









GACHE ELECTRIQUE ROUREG™ MINI
 ELECTRIC STRIKE ROUREG™ MINI
 ROUREG™ ELEKTRO-TÜRÖFFNER MINI
 ROUREG™ DEUROPENER MINI

SEM3CR

ST_SEM3CR_A_091201

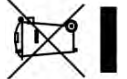
RACCORDEMENT
 CONNECTING
 ANSCHLUBPLAN
 AANSLUITING

● de série / standard execution / Standardausführung / standard uitvoering
 — non disponible / not available / nicht verfügbar / niet beschikbaar

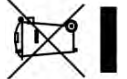
					
64,55 x 15,8 x 25,5 mm	0,1 kg	300° C	350 DaN		
ROUGE RED ROT ROOD					
3 ROUREG MINI					
A RUPTURE - FAIL SAFE - RUHESTROM - RUSTSTROOM					
MODELE MODEL MODELL					
SEM3CR	●	—	10,2 - 13,8 V DC	200 mA	
		2	20,4 - 27,6 V DC	100 mA	
DEVERROUILLAGE IMMEDIAT SOUS PRESSION JUSQU'A : IMMEDIATE UNLOCKING UNDER LOAD UP TO : TÜRÖFFNUNG BEI EINER LAST VON BIS ZU : ONTGRENDELING ONDER DRUK VAN :					
			DC = 3 DaN	AC = 12 DaN	

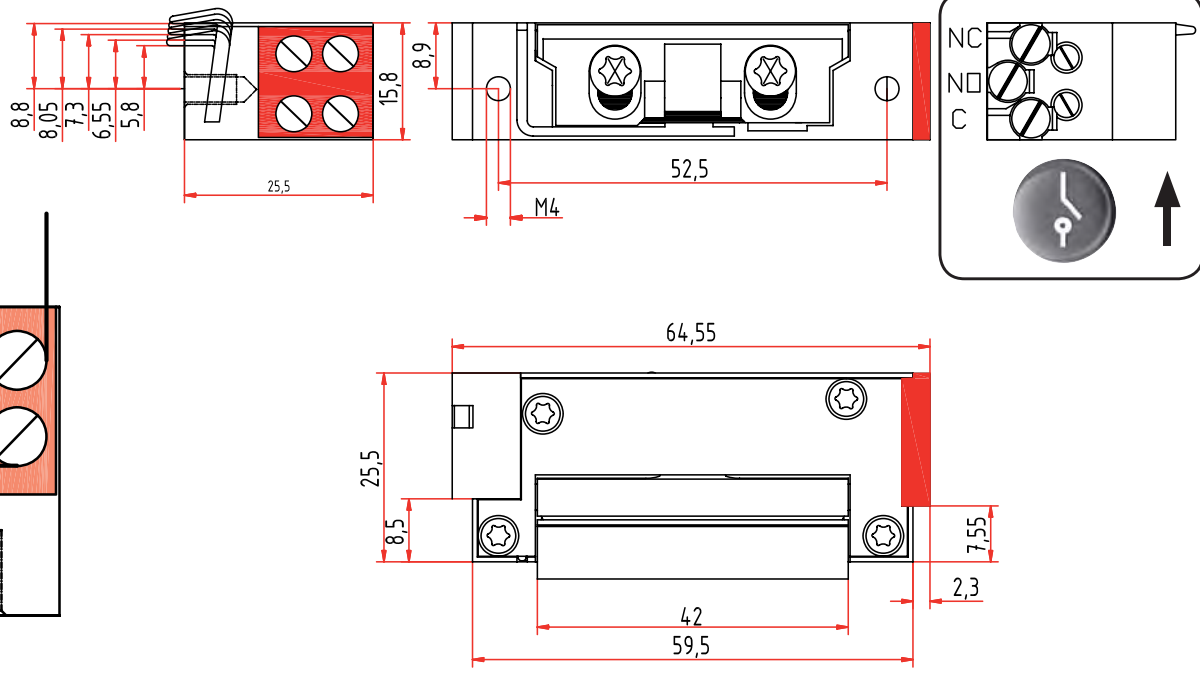
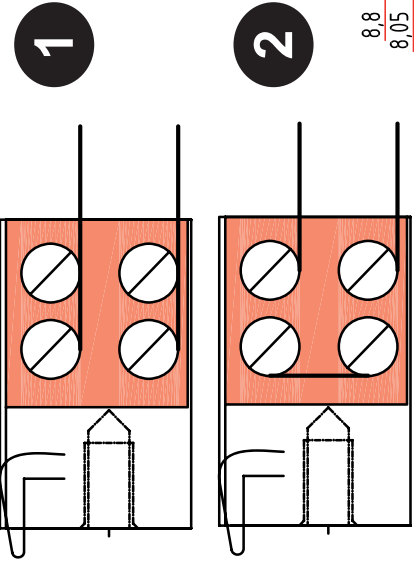

13b rue Saint-Exupéry CS20152 F-67503 HAGUENAU CEDEX ☎ +33 (0)3 90 59 02 20 📠 +33 (0)3 90 59 02 19
 Sous réserve de modifications techniques - Technical changes reserved! - Änderungen vorbehalten!

