

BOUTON POUSSOIR

infrarouge

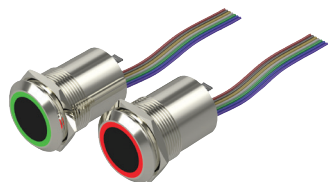

PB22IR





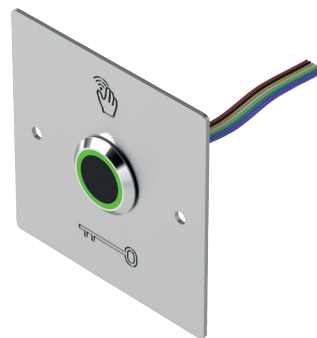

PB22IR_E



PB22IR_L

CARACTÉRISTIQUES PRODUITS

Références					
PB22IR	30V DC - 1 A	-10 +55°C	20	5 - 20 cm	0,5 - 20 s



Sans contact



LEDs pilotables

Code article	Description article	Poids en kg	Code douanier
PB22IR	Bouton poussoir lumineux infrarouge bicolore 12/24V DC relais inverseur et tempo réglable	0,03	85365080
PB22IR_E	Bouton poussoir lumineux infrarouge bicolore 12/24VDC avec plaque étroite	0,062	85365080
PB22IR_L	Bouton poussoir lumineux infrarouge bicolore 12/24VDC avec plaque large	0,097	85365080

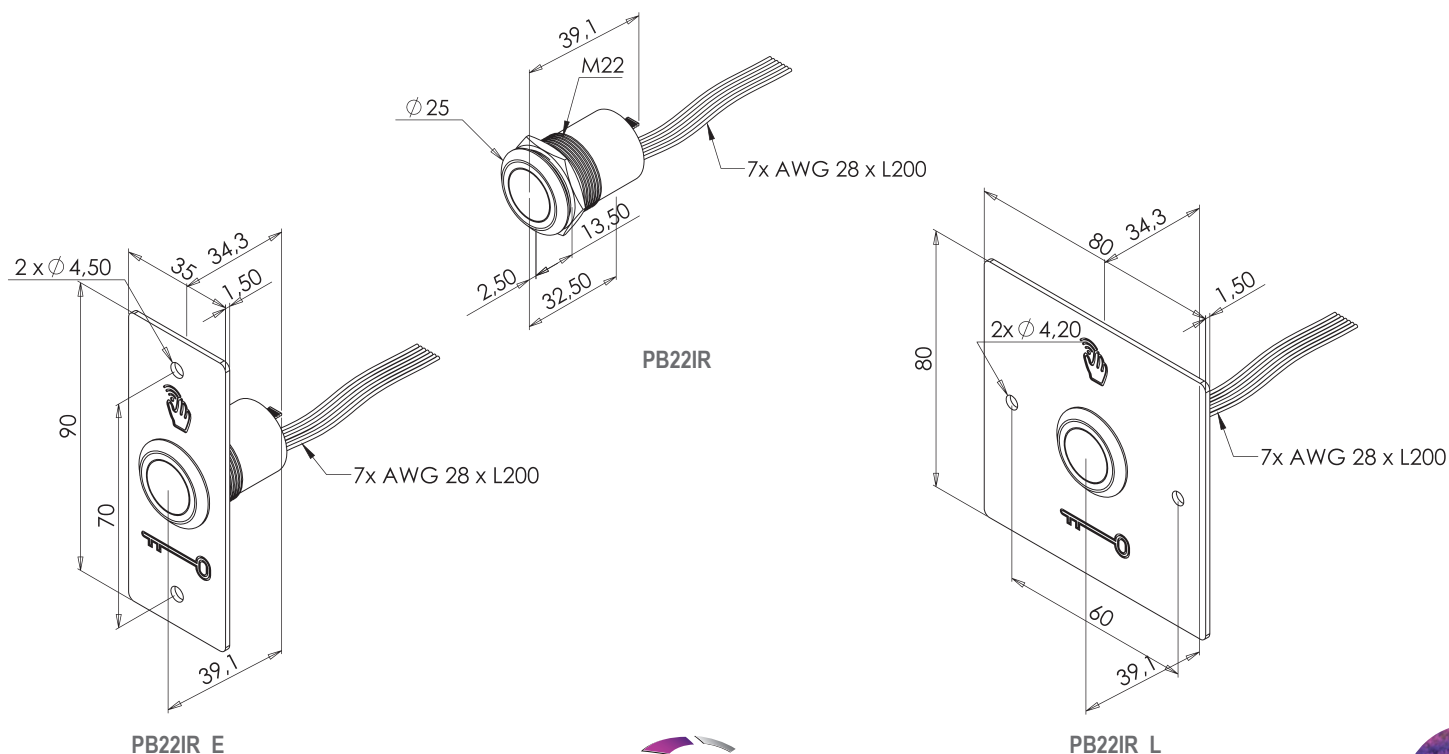

BOUTONS POUSSOIRS DIVERS

